

Pathfinder...Providing innovative tactile systems

Discreet tactile, Polyurethane with star shaft

Specifications

Product name: Pathfinder – Discreet tactile Polyurethane with star shaft

Product code: PFSA THISS12 PFSA THISS25

Tactile ground surface indicator (discreet) hazard system type.

Manufacturing Material: Engineered Polyurethane

Manufactured to meet the 1428.4.1.2009 AS/NZ Standards



Suitable substrate for installation:

Concrete, Asphalt, Timber, Pavers, Tile surfaces.

CSIRO slip test results

Wet pendulum test = **V**

Oil/Wet ramp test = **R11**

(reports available on request)

Colours:

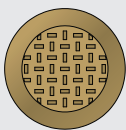

Beige
PMS: 465C



Black
Process Black

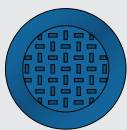

Blue
PMS: 3015C

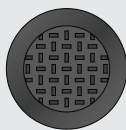

Charcoal
PMS: 425c

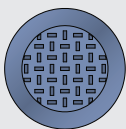

Cobalt
PMS: 652J

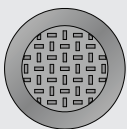

Grey
PMS: 429C



Terracotta
PMS: 1875C



Yellow
PMS: 108C

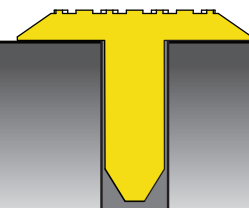
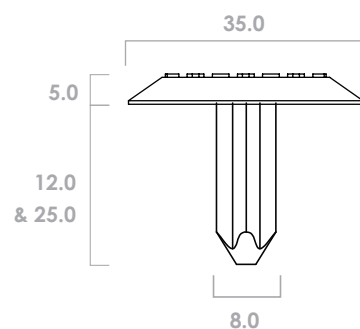
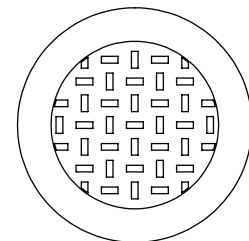

pathfindersystems

Pathfinder Systems Australia Pty Ltd

Telephone: 1300 362 775

Email: enquiries@pathfindersystems.com.au

ABN: 45 095 789 423